

Rectangular front flange (Not according to ISO standard)

Type O1

MF1

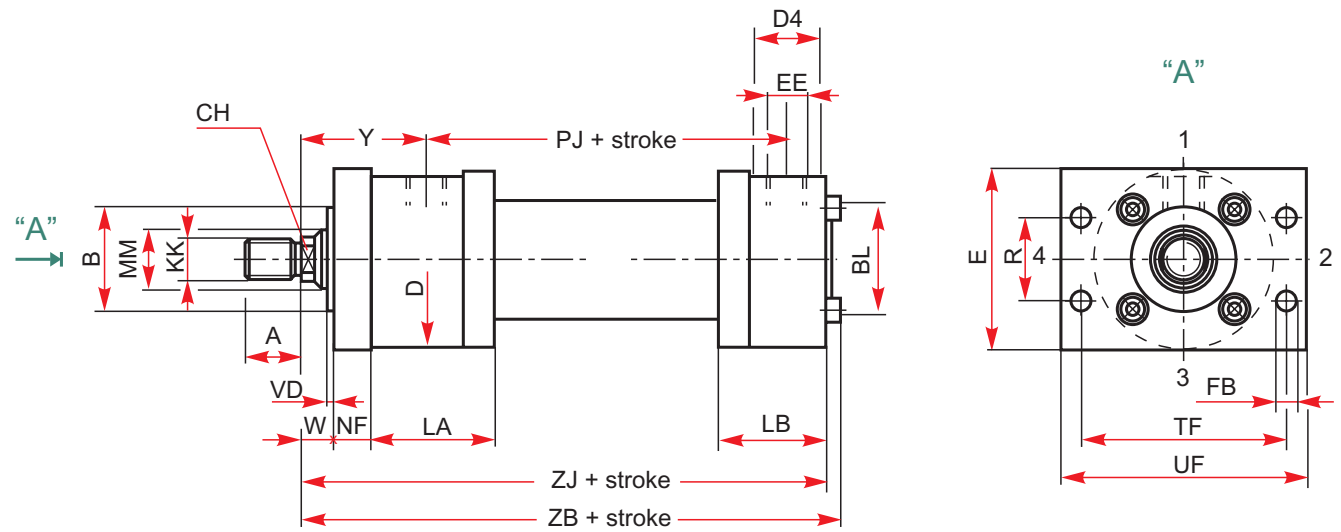
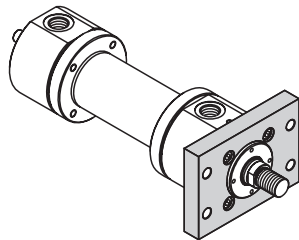

Rectangular rear flange (Not according to ISO standard)

Type O2

MF2

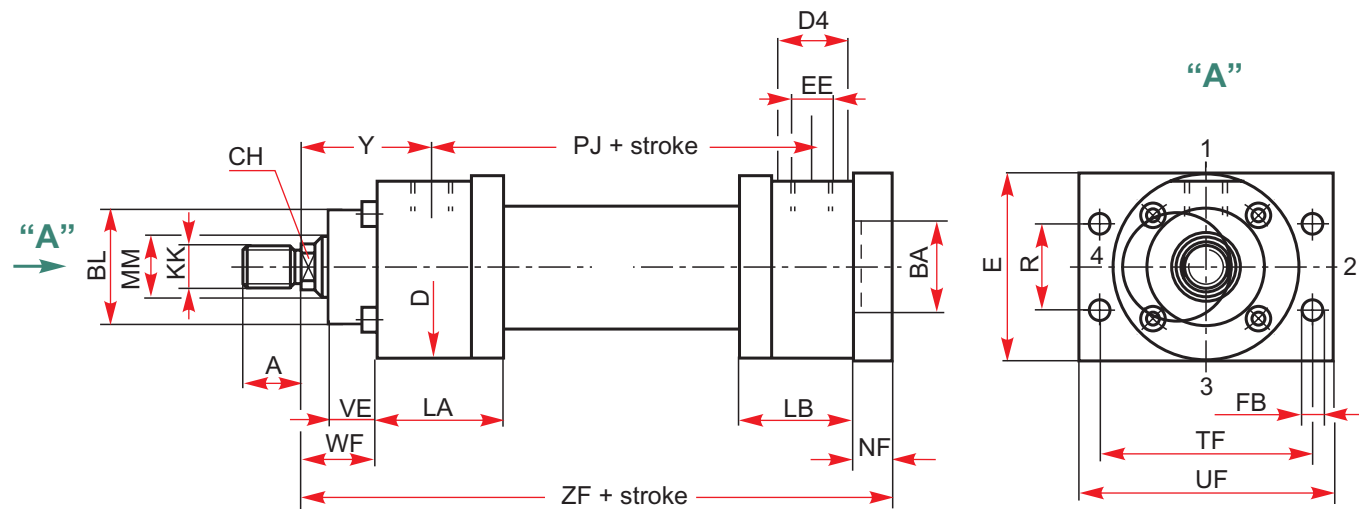
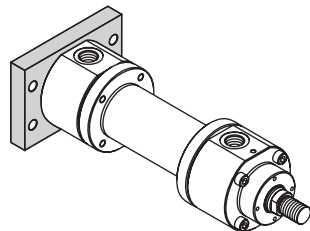

Rectangular front flange

(Not according to ISO standard)

Type 01

MF1

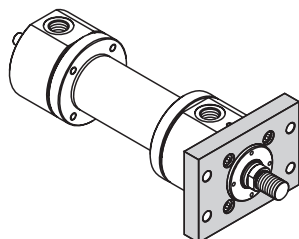

Rectangular rear flange

(Not according to ISO standard)

Type 02

MF2

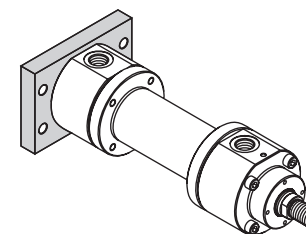

Remarks:

- 2) = Thread version Y (to ISO 6020/1)
3) = Thread version W (VW standard VW 39 D 920)

MM - Rod diameter

Bore Ø	MM Ø	ISO 6020/1		VW 39 D920		CH	BL f8	D Ø	D4 max.	EE	Y	PJ +stroke	VE	WF	NF	VD	W	B/BA f8/E9	ZJ +stroke	ZB +stroke	E max.	R js13	TF js13	UF max.	FB H13	LA ±1	LB ±1
		KK ²⁾	A ²⁾	KK ³⁾	A ³⁾																						
25	14	M12x1,25	16	-	-	12	32	56	25	G1/4	58	77	15	28	12	3	16	32	150	158	60	28,7	69,2	85	6,6	59	44
	18	M14x1,5	18	M12x1,25	16	14																					
32	18	M14x1,5	18	-	-	14	40	67	28	G3/8	64	89	19	32	16	3	16	40	170	178	70	35,2	85	105	9	65	50
	22	M16x1,5	22	M14x1,5	18	17																					
40	22	M16x1,5	22	-	-	17	50	78	34	G1/2	71	97	19	32	16	3	16	50	190	198	80	40,6	98	115	9	75	58
	28	M20x1,5	28	M16x1,5	22	22																					
50	28	M20x1,5	28	-	-	22	60	95	34	G1/2	72	111	24	38	20	4	18	60	205	213	100	48,2	116,4	140	11	74	62
	36	M27x2	36	M20x1,5	28	28																					
63	36	M27x2	36	-	-	28	73	116	42	G3/4	82	117	29	45	25	4	20	70	224	234	120	55,5	134	160	13,5	82	70
	45	M33x2	45	M27x2	36	36																					
80	45	M33x2	45	-	-	36	93	130	42	G3/4	91	134	36	54	32	4	22	85	250	260	135	63,1	152,5	185	17,5	89	77
	56	M42x2	56	M33x2	45	46																					
100	56	M42x2	56	-	-	46	114	158	47	G1	108	162	37	57	32	5	25	106	300	310	160	76,5	184,8	225	22	114	93
	70	M48x2	63	M42x2	56	60																					
125	70	M48x2	63	-	-	60	140	192	47	G1	121	174	37	60	32	5	28	132	325	335	195	90,2	217,1	255	22	127	96
	90	M64x3	85	M48x2	63	75																					

* Unless otherwise specified, all dimensions are given in millimetres.



How to order a HYDROMAT M1 series cylinder compliant with ISO 6020/1

The HYDROMAT M1 series cylinders compliant with ISO 6020/1 standards are provided with an identification code which describes the construction specifications in a non-ambiguous way. To make up the code for the order, follow the code diagram set out below and insert the letters identifying the various features of the desired cylinder in the sequence given below.

Features	Description	Code
Series	M1 Differential cylinder according to ISO 6020/1 M1 Double rod cylinder ¹⁾ M1 Cylinder with linear transducer ¹⁾	M1CD M1DK M1CT
Bore	Specify bore in mm (indicate 3 figures)	-
Rod MM (diameter)	14 mm (bore 25) 18 mm (bore 25 and 32) 22 mm (bore 32 and 40) 28 mm (bore 40 and 50) 36 mm (bore 50 and 63) 45 mm (bore 63 and 80) 56 mm (bore 80 and 100) 70 mm (bore 100 and 125) 90 mm (bore 125 and 160) 110 mm (bore 160 and 200) 140 mm (bore 200)	B D F H L M P R T V Z
Stroke	Specify the stroke in mm (indicate 4 figures)	-
Cushioning	Without cushioning Front cushioning Rear cushioning ¹⁾ Cushioning on both ends ¹⁾ Double rod without cushioning Double rod with cushioning	C E G P S T
Rod end	Thread (ISO 6020/1) Thread (VW standard VW 39 D 920)	Y W
Mounting type	Basic version (not in line to ISO 6020/1) Rectangular front flange -MF1 (not in line to ISO) Rectangular rear flange -MF2 (not in line to ISO) Side foot - MS2 Intermediate fixed trunnion - MT4 Rear clevis - MP3 Rear spherical bearing - MP5 Round front flange - MF3 Round rear flange - MF4	00 01 02 03 06 07 08 13 14

¹⁾ Not available for bores 25, 32, 40 (rods 14, 18 i 22), see page 43

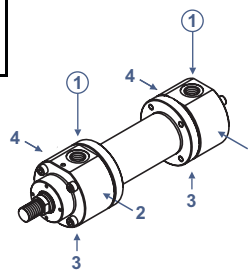
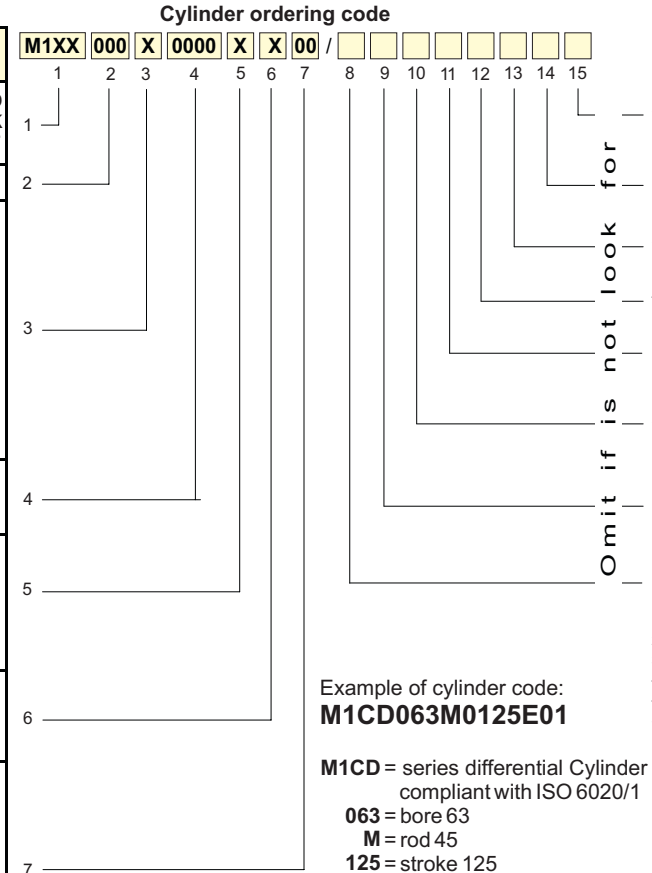

- When issuing the order for the cylinder, provide the following information:
- code identifying the model
 - quantity
 - special features (if requested) with any enclosed sketches and/or construction drawings
 - operating conditions for special uses
 - delivery date with type of priority

Code	Description	Features
K00	Specify the position of the front and rear inductive sensors	Position of inductive sensors
S00	Specify the position of the front and rear air bleeds	Position of air bleeds
R00	Specify the position of the front and rear braking adjustment devices	Position of braking adjustment devices
P00	Specify the position of front and rear connections	Position of connections
-	Specify the number of spacers (multiples of 50 mm)	Spacers
T U ²⁾ V ³⁾ Z	Seals for water and glycol mixtures Low friction seals Seals for high temperatures and/or aggressive fluids Seals for heavy application - Chevron seals	Seals
D ⁴⁾ E ⁴⁾ F ⁴⁾	Front inductive sensor Rear inductive sensor Front and rear inductive sensor	Inductive sensors
A B C ⁵⁾	Front air bleed Rear air bleed Front and rear air bleeds	Air bleed

- 2) Minimum working pressure: 20 bar
- 3) Max. working temp. for M1CT and M1CD series cyl. fitted with inductive sensors: 70 °C
- 4) Using inductive sensors, the cylinder must be provided with cushioning (front or rear)
- 4) Not available for bores 25 and 32, see page 42
- 5) Compulsory for M1CT series cylinders

Example of cylinder code:
M1CD063M0125E01

M1CD = series differential Cylinder compliant with ISO 6020/1
063 = bore 63
M = rod 45
125 = stroke 125
E = front cushioning
01 = rectangular rear flange MF1 (not compliant with ISO standards).

The positions of the inlet connections and front cushion are standard so they are not specified in the order code (oil feeding inlets side 1 on head and cap - cushion side 3 on head and cap - specified in Table 19 on page 62).

Example of cylinder code:
M1CD125T0800PW03/FUP14K22

M1CD = series differential Cylinder compliant with ISO 6020/1 standards
125 = bore 125, **T** = rod 90, **0800** = stroke 800,
P = cushioning on both ends,
W = thread rod ends (VW standard VW 39 D 920)
03 = side foot (ISO MS2)
F = front and rear inductive sensor, **U** = low friction seals
P = position of incoming connections side 1 on the head and side 4 on the cap
K = position of inductive sensor side 2 on head and 2 on cap

- standard cushion position side 3 on head and cap (see Table 19 on page 62).